

# Verschillende uitvoeringen aangedreven rollen

## Kunststof rollen

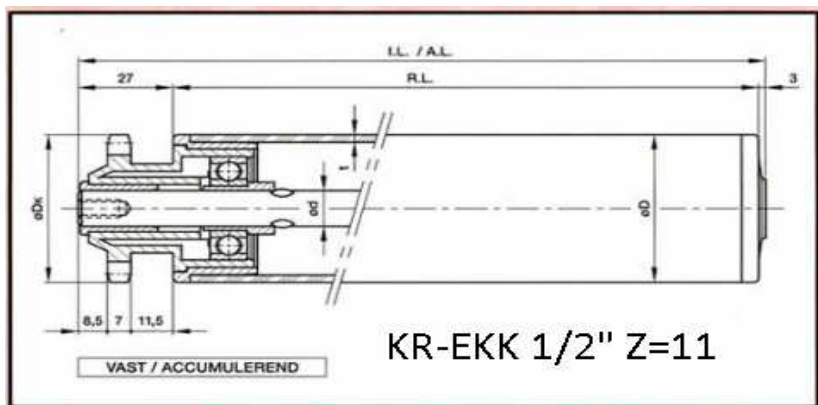

EKK 1/2" Z=11 enkel  
(art 78000100)

Kunststof rol Ø50x2,8  
vv kunststof EKK kettingwiel

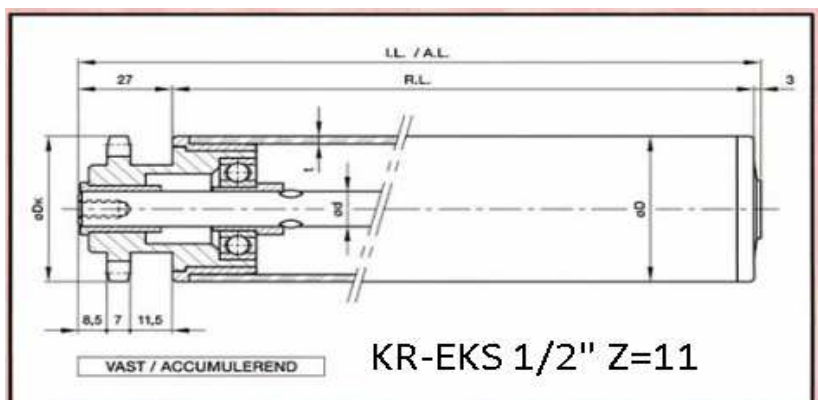

EKS 1/2" Z=11 enkel  
(art 78000107)

Kunststof rol Ø50x2,8  
vv stalen EKS kettingwiel

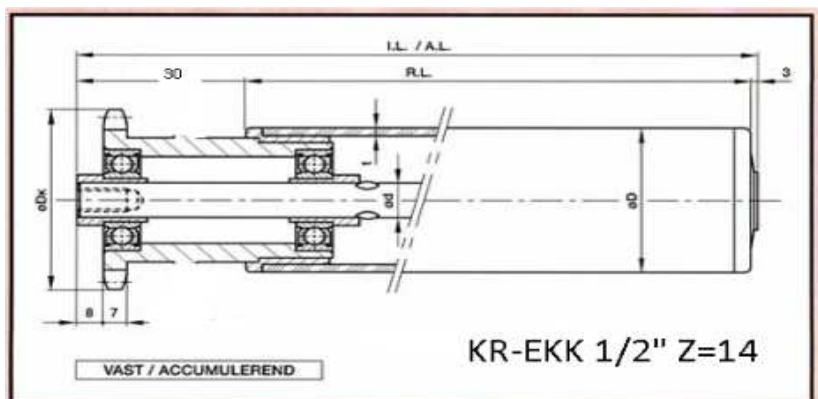

EKK 1/2" Z=14 enkel  
(art 78000105)

Kunststof rol Ø50x2,8  
vv kunststof EKK kettingwiel

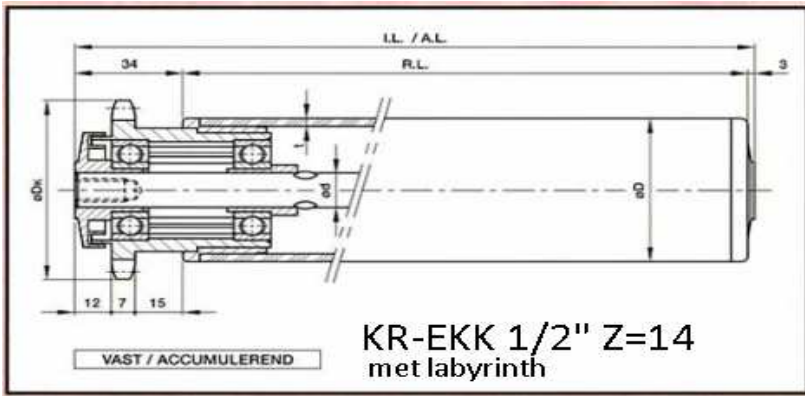

EKK 1/2" Z=14 enk labyrinth  
(art 78000102)  
Kunststof rol Ø50x2,8  
vv kunststof EKK ketting wiel  
met stofkap labyrinth

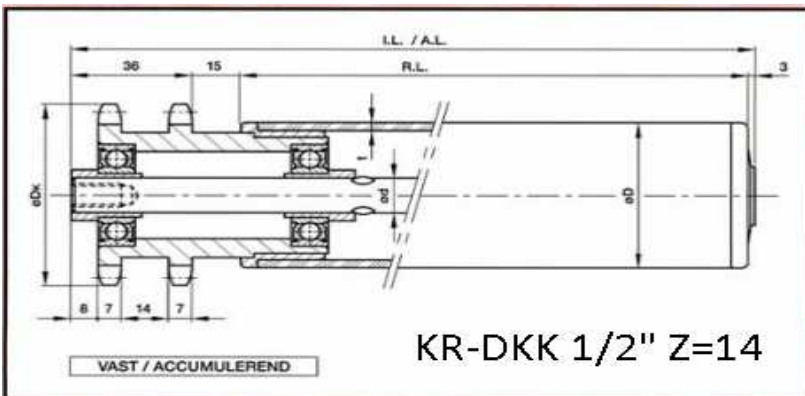

DKK 1/2" Z=14 dubbel  
(art 78000103)  
Kunststof rol Ø50x2,8  
vv kunststof DKK ketting wiel

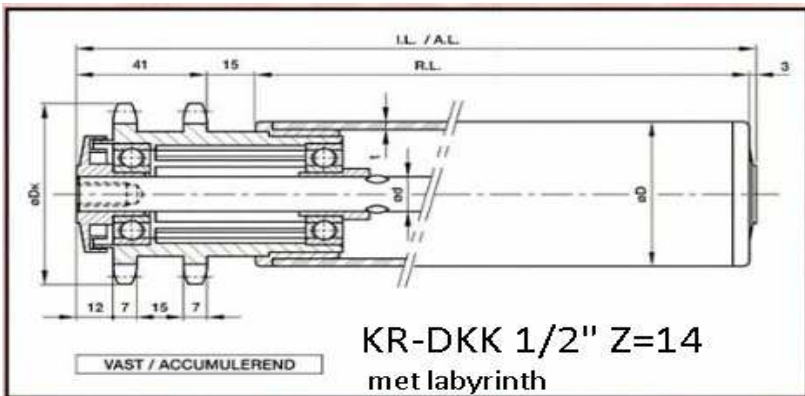

DKK 1/2" Z=14 dub labyrinth  
(art 78000101)  
Kunststof rol Ø50x2,8  
vv kunststof DKK ketting wiel  
met stofkap labyrinth

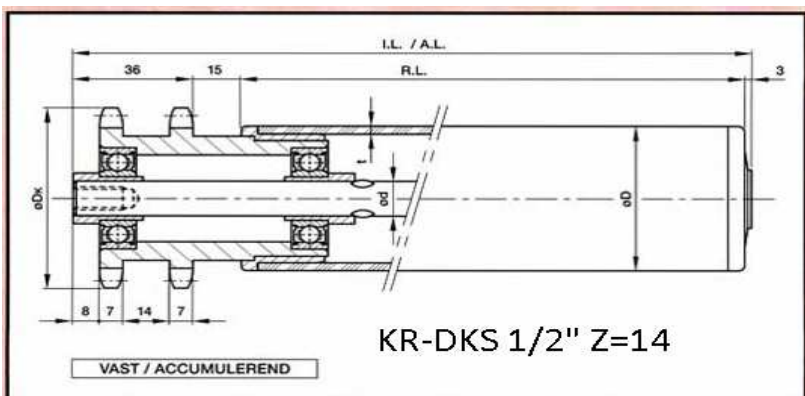

DKS 1/2" Z=14 dubbel  
(art 78000109)  
Kunststof rol Ø50x2,8  
vv stalen DKS ketting wiel

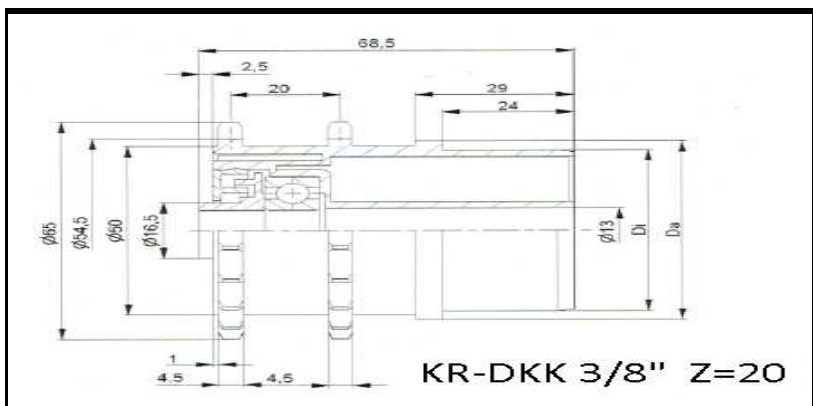

DKK 3/8" Z=20

(art 78000130)

Kunststof rol  $\phi 50 \times 2,8$   
vv kunststof DKK kettingwiel

## stalen rollen

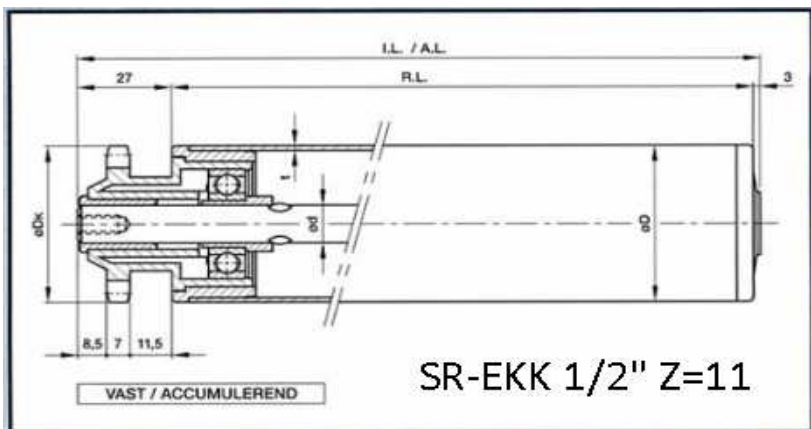

EKK 1/2" Z=11 enkel

(art 78000100)

Stalen rol  $\phi 50 \times 1,5$   
vv kunststof EKK kettingwiel

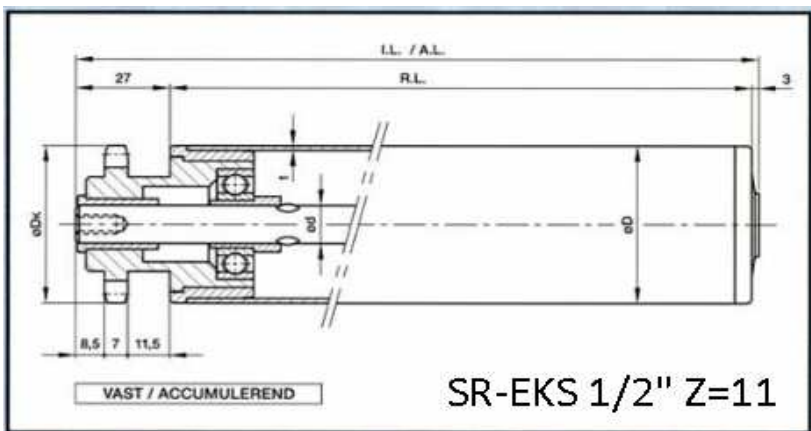

EKS 1/2" Z=11 enkel

(art 78000107)

Stalen rol  $\phi 50 \times 1,5$   
vv stalen EKS kettingwiel

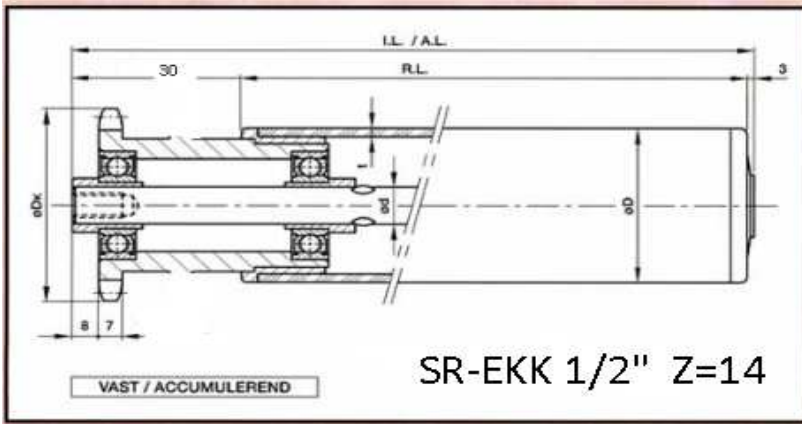

EKK 1/2" Z=14 enkel  
(art 78000105)

Stalen rol Ø50x1,5  
vv kunststof EKK kettingwiel

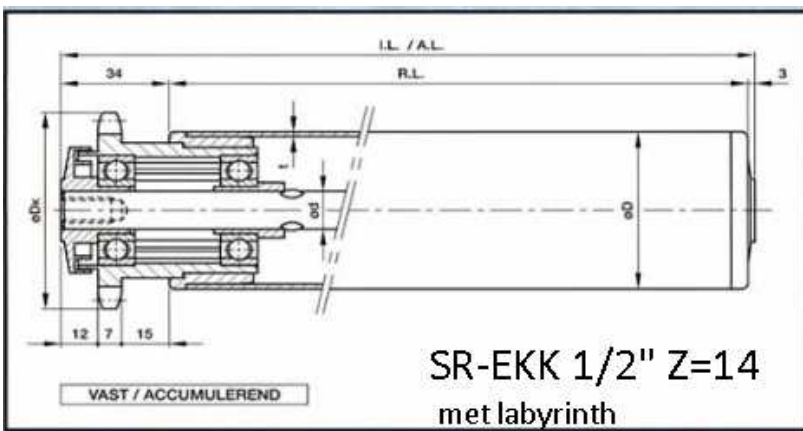

EKK 1/2" Z=14 enk labyrinth  
(art 78000102)

Stalen rol Ø50x1,5  
kunststof EKK kettingwiel enkel  
met stofkap labyrinth

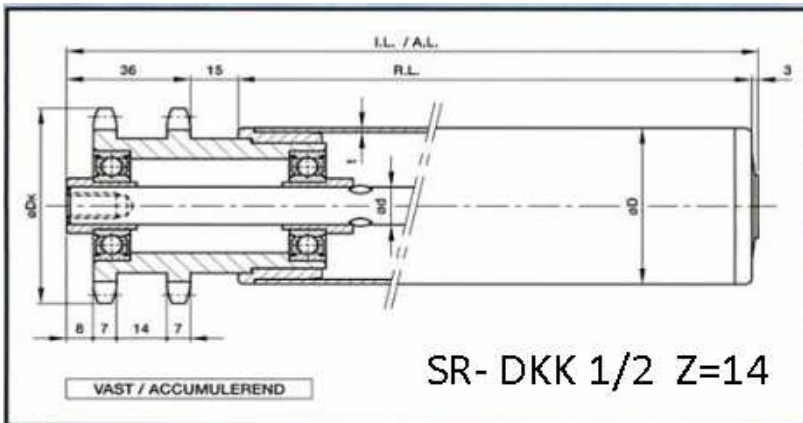

DKK 1/2" Z=14 dubbel  
(art 78000103)

Stalen rol Ø50x1,5  
vv kunststof DKK kettingwiel  
1/2" Z=14 dubbel

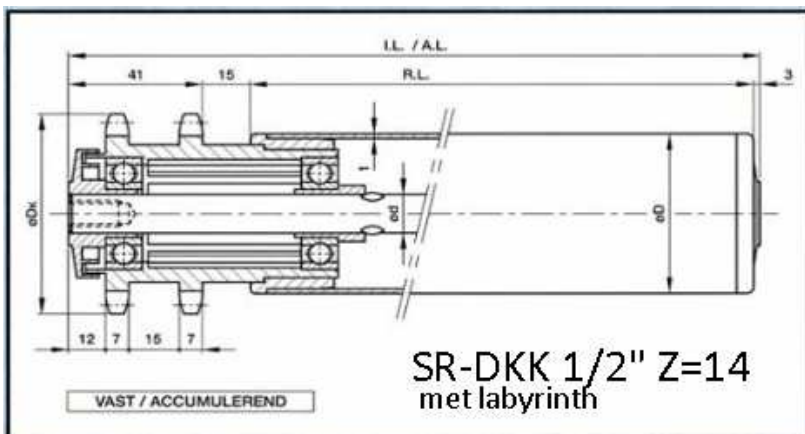

DKK 1/2" Z=14 dub labyrinth  
(art 78000101)

Stalen rol Ø50x1,5  
kunststof DKK ketting wiel dubbel  
met stofkap labyrinth

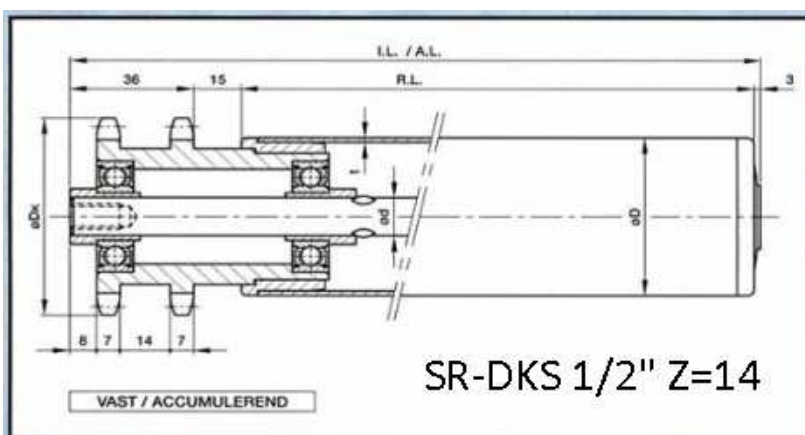

DKS 1/2" Z=14 dubbel  
(art 78000109)

Stalen rol Ø50x1,5  
vv stalen DKS ketting wiel  
1/2" Z=14 dubbel

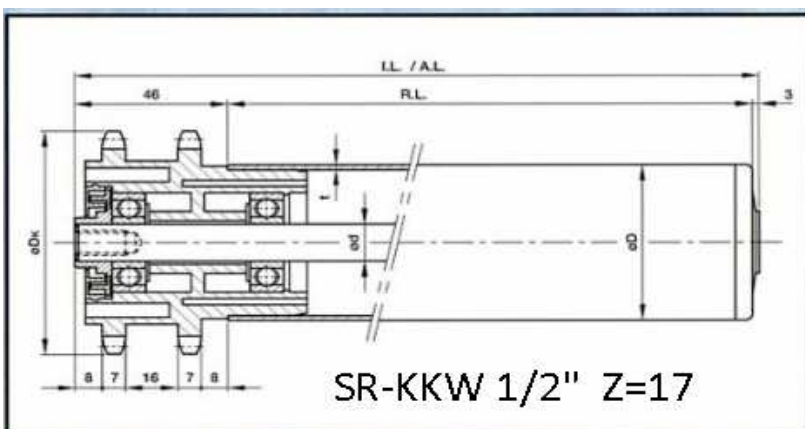

DKK 1/2" Z=17 dubbel  
(art 78000106)

Stalen rol Ø50x1,5  
vv kunststof KKW ketting wiel  
1/2" Z=17 dubbel



# Konische rollen

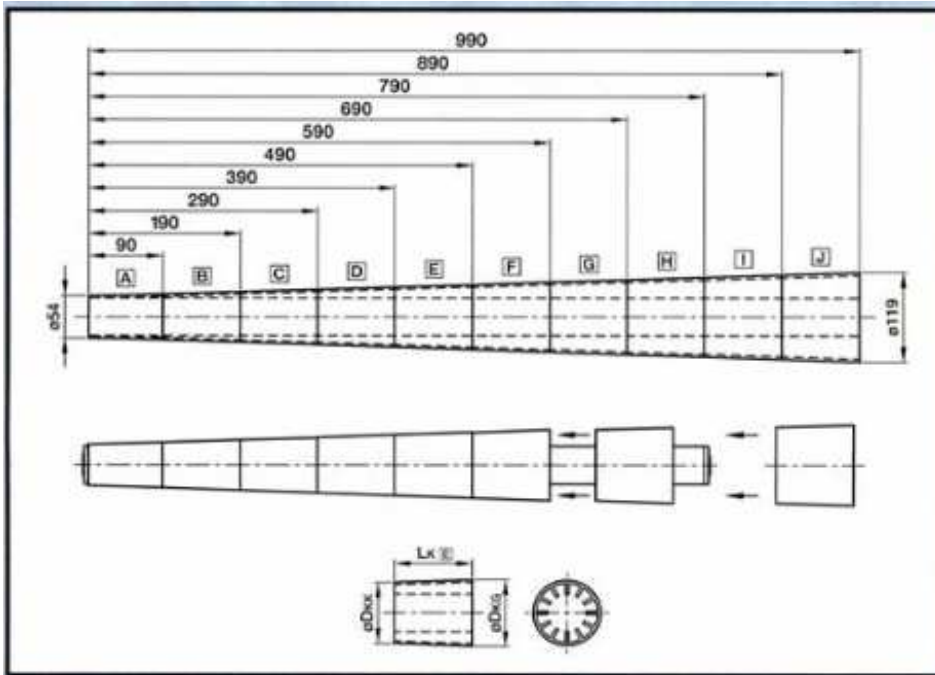

Materiaal:  
Kunststof Polypoeen

Deel	A	B	C	D	E	F	G	H	I	J
LK [A]—[J]	90	100	100	100	100	100	100	100	100	100
oDkK	54	60	66	73	79,5	86	93	100	106	112
oDkG	60	66	73	79,5	86	93	100	106	112	119

RL= Totale konische lengte + 10mm  
Koniciteit = 4 graden

## Onderdelen



### Kogellager 6202 in:

- \* open
- \* ZZ (stalen afdichting)
- \* 2RS (kunststof afdichting)
- \* RVS (roestvaststaal)



### Verloopring:

- \* voor vaste uitvoering
- \* voor accumulerende uitvoering
  
- \* buis 50x1,5
- \* buis 50x2,8
- \* buis 51x2
- \* buis 60x2



### Astule:

- \* voor as 10mm (15/10)
- \* voor as 12mm (15/12)
- \* voor as 14mm (15/14)
- \* voor as 15mm geen tule nodig